

Dimensions

550 Northfield

560 Bridgeport

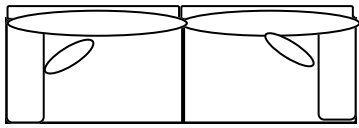

-011 2 over 2 Sofa
85x38x35
-013 3 over 3 Sofa

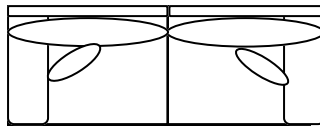

-010 Loft Sofa
72x38x35

550 - use 729-009 Ottoman
560 - use 728-009 Ottoman
40x30x17

Available with Topstitching.
Add T to style (550-011T)

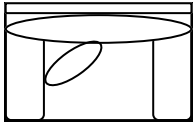

-001 Lounge Chair
45x38x35

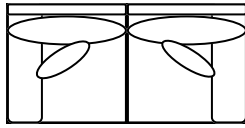

-019 Loveseat
62x38x35

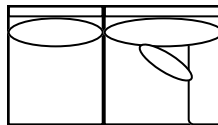

-084 RSF 1-Arm Loveseat
54x38x35

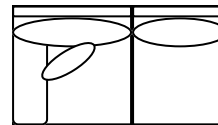

-086 LSF 1-Arm Loveseat
54x38x35

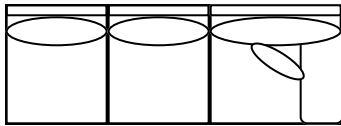

-080 RSF One Arm Sofa
-017 RSF One Arm Q Sleeper
78x38x35

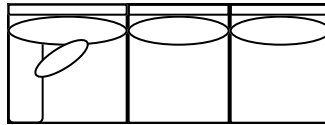

-081 LSF One Arm Sofa
-018 LSF One Arm Q Sleeper
78x38x35

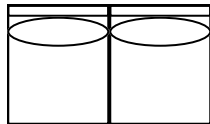

-083 Armless Loveseat
46x38x35

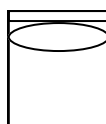

-091 Armless Chair
23x38x35

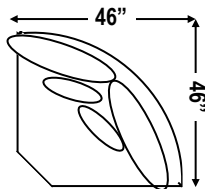

-095 Corner Wedge
43x38x35
65 widest point

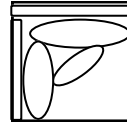

-090 Corner
38x38x35

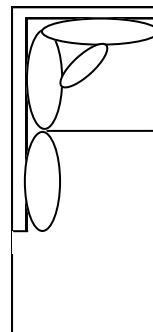

-0B3 LSF 1-Arm Bumper Section
-0B4 RSF 1-Arm Bumper Section
38x94x35

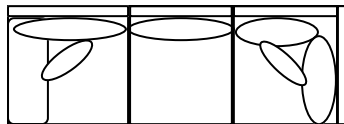
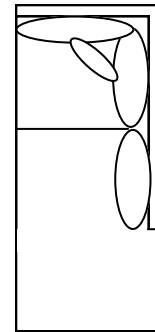

-0A3 LSF One Arm Sofa Section
92x38x35
To be used with one-arm sofa, sleeper, loveseat, or chair only.
Will create a 92" L-shaped sectional.

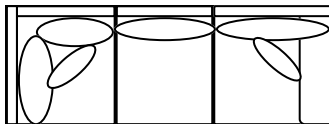

-0A4 RSF One Arm Sofa Section
92x38x35
To be used with one-arm sofa, sleeper, loveseat, or chair only.
Will create a 92" L-shaped sectional.

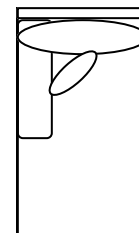

-087 LSF One-Arm Chaise
-085 RSF One-Arm Chaise
35x65x35

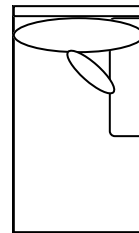

Sleeper mattresses are 72" in length.
Total depth of sleeper with extended mattress is 93".
(See diagram on right.)

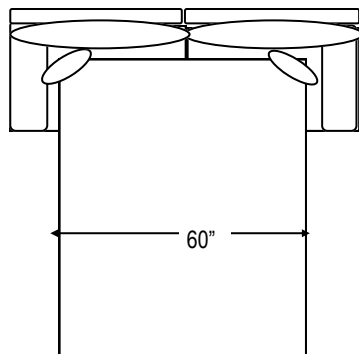

-015 2 over 2 Queen Sleeper
85x38x35
-0153 3 over 3 Queen Sleeper

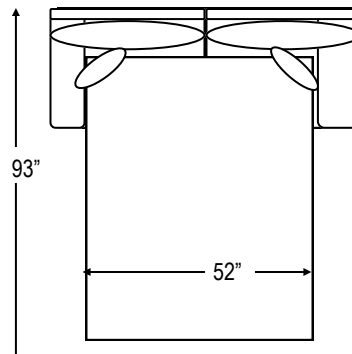

-016 Loft Sofa w/ Full Sleeper
74x38x35

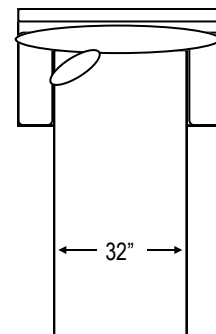

-014 Twin Sleeper
55x38x35

